

**NEW
PRODUCT**

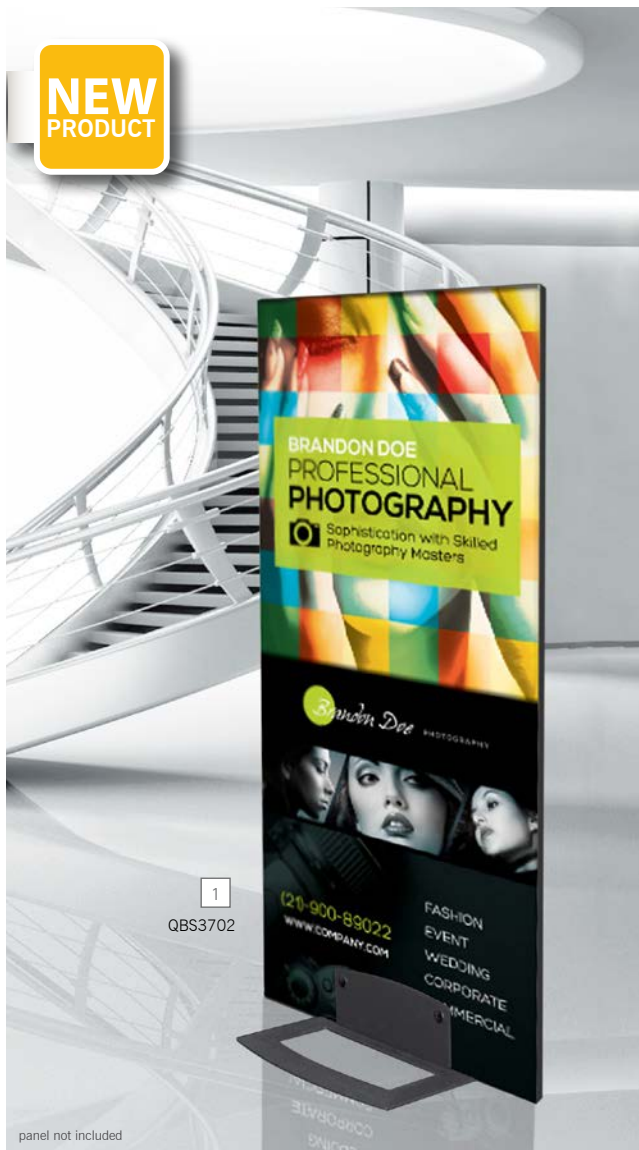

1
QBS3702

panel not included

information

- sistema ad incastro in metallo verniciato a polvere color antracite, due versioni diverse, per pannelli leggeri o pesanti
klemmsystem aus pulverbeschichteten metall, zwei versionen für leichte und schwere paneele
clamping system made of powder-coated metal, two different versions for heavy and lightweight panels
- spessore 2mm, peso 2 kg, per carico fino a max. 3kg
2mm stärke, 2 kg gewicht, bis max. 3kg traglast
2 mm thickness, 2 kg weight, for a maximum load of 3kg
- spessore 4mm, peso 3,84 kg, per carico fino a max. 10 kg
4mm stärke, 3,84 kg gewicht, bis max. 10kg traglast
4 mm thickness, 3,84 kg weight, for a maximum load of 10kg

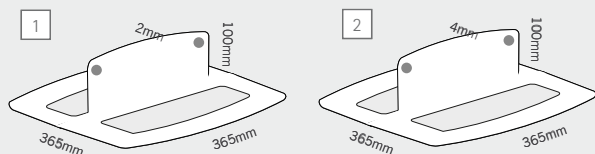

quickbase

MADE IN EU design by KD

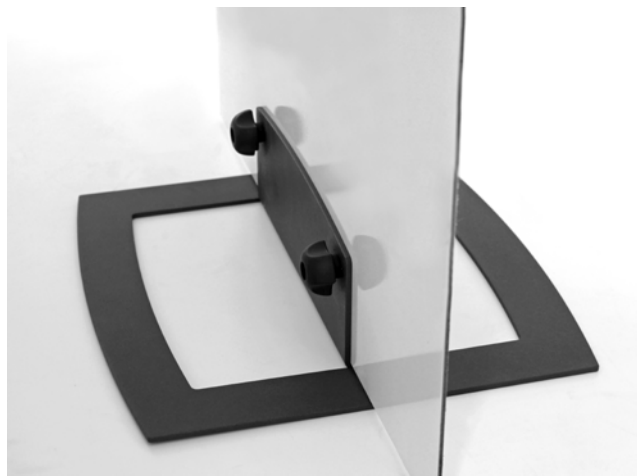

IT la sua base per pannelli informativi, pubblicitari o per elementi decorativi con sistema ad incastro adatta sia per spazi interni che esterni. quickbase è la scelta perfetta per chiunque cerchi una base piatta e leggera. con quickbase possono essere utilizzati pannelli di diversi materiali come dibond, plexiglas, metallo o materiali sintetici. grazie al sottile ed elegante design del profilo in metallo, la sua presentazione sarà sempre impeccabile. la base può essere fornita con 2 mm di spessore (QBS3702) per pannelli leggeri o con 4 mm di spessore (QBS3704) per materiali più pesanti.

DE ihre paneelbasis mit klemmsystem für info- und werbetafeln oder dekorative elemente im innen- und außenbereich. für alle, die einen flachen, leichten standfuß suchen, ist quickbase die perfekte wahl! unterschiedliche arten von platten aus dibond, plexiglas, metall und kunststoff etc. werden gleichmäßig eingespannt. durch die schmale optik des metallprofils kommt ihre information bestens zur geltung. quickbase ist lieferbar mit 2mm stärke (QBS3702) für leichte paneele und mit 4mm stärke (QBS3704) für schwere materialien.

EN your new panel base with a clamping profile for information and advertising boards or decorative elements in interior and exterior areas. quickbase is the perfect choice for anybody who is looking for a flat and light base. different types of materials like dibond, plexiglas, metal or other synthetic materials are safely fastened. thanks to the slim appearance of quickbase your information is shown in full. quickbase is available with 2mm thickness (QBS3702) for light panel materials or with 4mm thickness (QBS3704) for heavier panels.

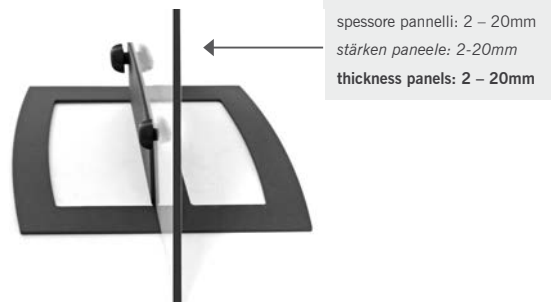

quickbase

1	QBS3702	quickbase 2mm, 1pc
2	QBS3704	quickbase 4mm, 1pc



panel not included



sistema ad incastro in metallo verniciato a polvere color antracite, superficie ruvida

klemmsystem aus pulverbeschichteten anthrazitgrauem metall und rauer oberfläche

clamping system made of powder-coated anthracite metal, rough surface



montaggio sicuro con vite a testa zigrinata nel foro del pannello

sicheres fixieren mittels schwarzer rändelschraube in der lochbohrung des paneels

secure fastening with black knurled head screw through holes in the panel

- 3 powder-coated base
- 4 fixation board
- 5 knurled head screw
- 6 panel
- 7 screw

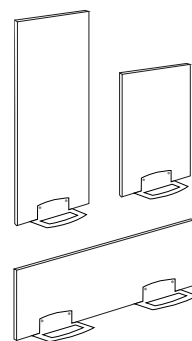
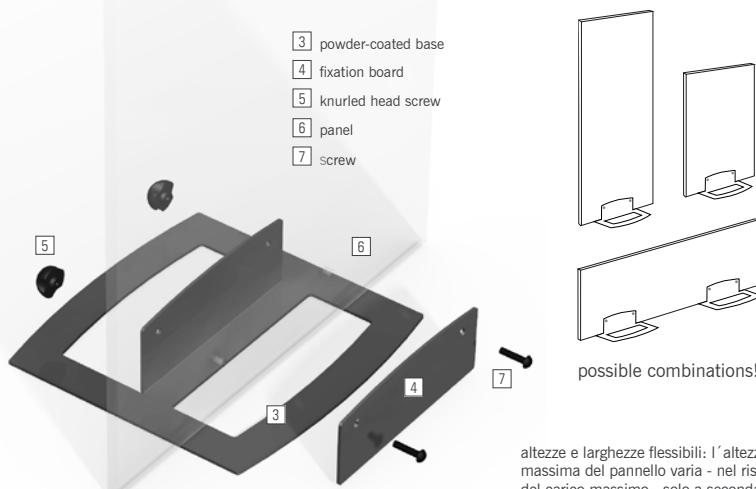





possible combinations!

altezze e larghezze flessibili: l'altezza massima del pannello varia - nel rispetto del carico massimo - solo a seconda della rigidità del materiale utilizzato.

flexible höhen und breiten: maximale hängen - bei beachtung der traglast - nur von der steifigkeit des verwendeten plattenmaterials ab.

flexible height and width: the maximum size is limited only by the rigidity of the panel and the maximum load.

advantages

- 
 tensione perfetta per tutti i tipi di pannelli
einspannen aller arten von platten möglich
easy mounting for all types of rigid panels
- 
 combinazione di più basi per pannelli extralarge
für lange paneele mehrere basen in reihe verwenden
use more quickbases together to display XL panels
- 
 ottima stabilità nonostante il peso leggero della base
hohe stabilität bei geringem gewicht
reduced weight yet still a stable display
- 
 nessun rischio di inciampare grazie alla base ultrapiatto
stolperschutz dank extrem flacher basis
tripping protection thanks to extremely flat base
- 
 resistente e duraturo grazie alla verniciatura a polvere del metallo
robust und langlebig dank pulverlackbeschichtung
robust and long life thanks to the powder-coated surface



nessun rischio di inciampare grazie al profilo ultrapiatto

stolperschutz dank extrem flachem profil

tripping protection thanks to extremely flat profiles

